

VALVE FITTING PART NUMBERS

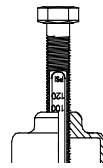

2" & 3" PRESSURE REDUCING VALVES*

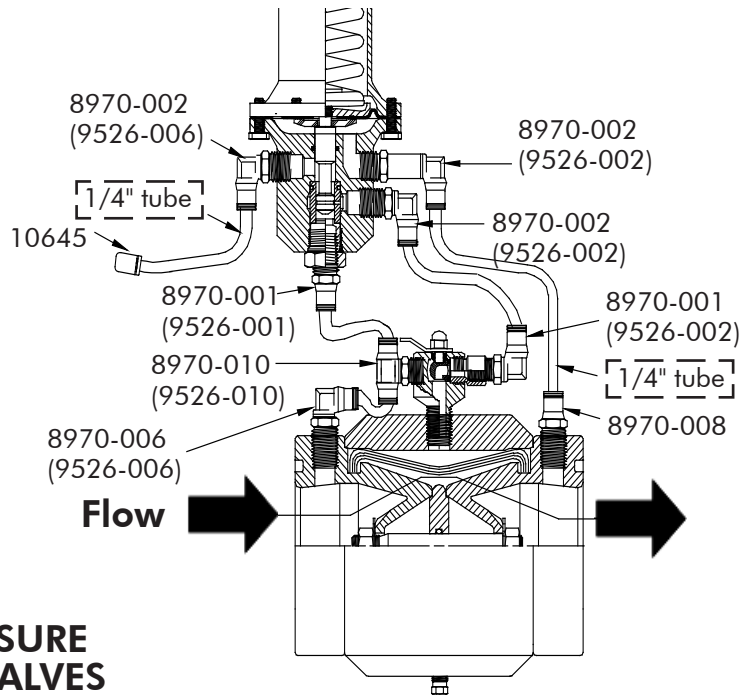

4" & 6" PRESSURE REDUCING VALVES

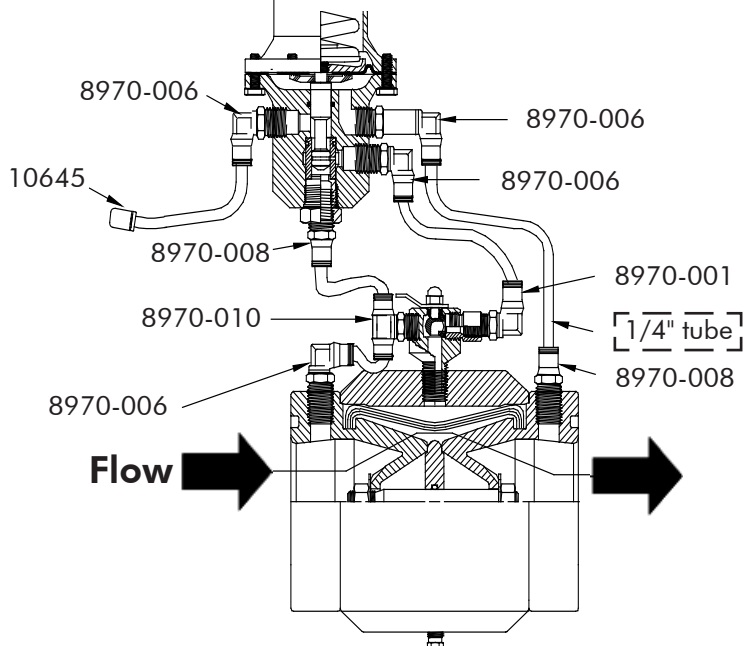

***ALL TUBE IS 1/4"**
NOTE: Before January of 1999 all tube was 5/32", except for 1/4" on downstream and vent as shown in dashed box. Part numbers for pre-99 are shown in parentheses.

13038

TUBING PROTECTION KIT

4 X 16" LONG SPRINGS, TRIM TO LENGTH AS NECESSARY

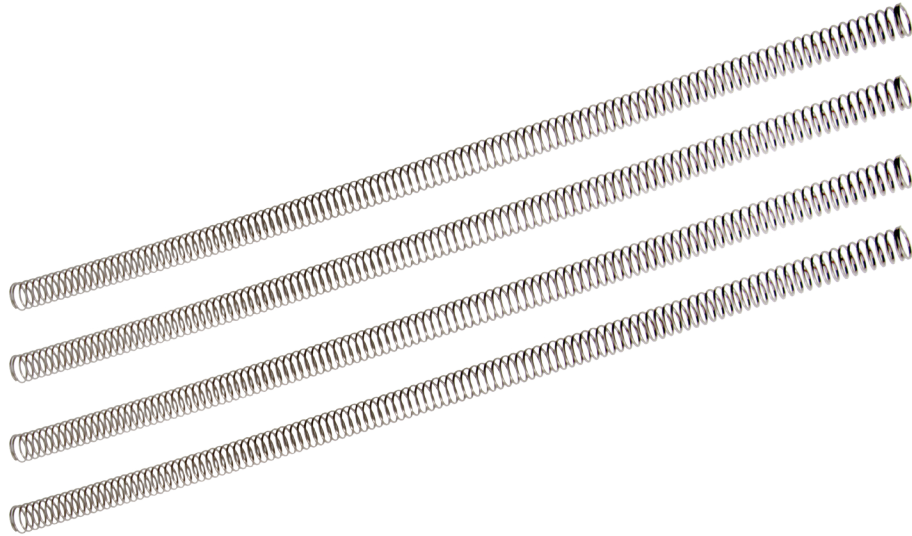

BALL DRAIN/VENT

P/N 10753

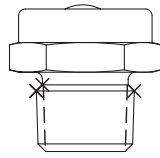

1 10752
BALL/DRAIN VENT

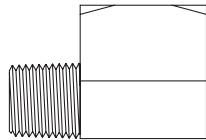

1 12399
REDUCING ELBOW,
LOW CLEARANCE
1/4" FNPT X 1/8" MNPT

4" PAPER GASKET 9144

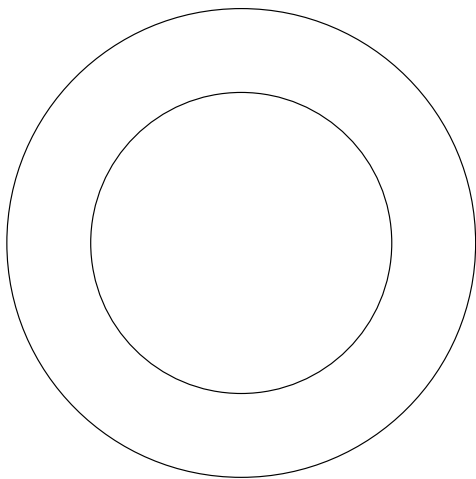

6" PAPER GASKET 8984

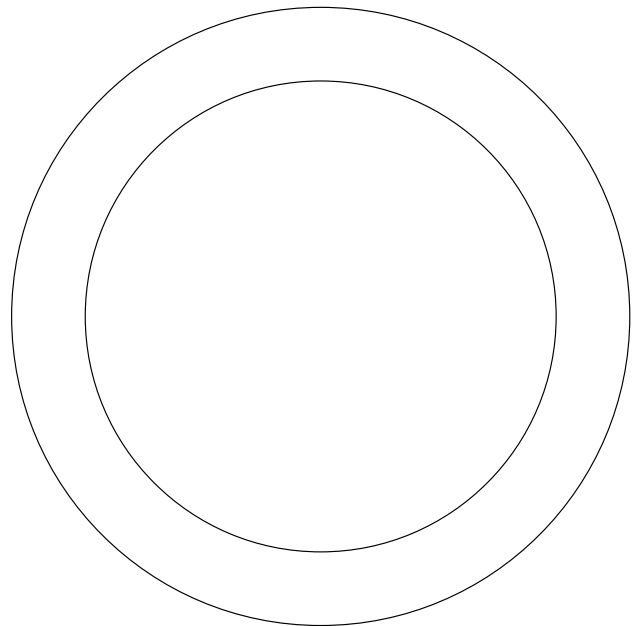

BRASS PIPE FITTINGS

<p>1/4" BRASS PLUG</p> <p>6089</p>	<p>STREET TEE, 1/4" FNPT X 1/4" MNPT X 1/4" FNPT</p> <p>8971</p>	<p>TEE, 1/4" FNPT</p> <p>8971-001</p>
<p>REDUCING HEX NIPPLE, 1/2" MNPT X 3/8" MNPT</p> <p>8971-002</p>	<p>REDUCING HEX NIPPLE, 1/2" MNPT X 1/4" MNPT</p> <p>8971-003</p>	<p>REDUCING HEX NIPPLE, 1/4" MNPT X 1/8" MNPT</p> <p>8971-004</p>
<p>ADAPTER, 1/4" FNPT X 1/8" MNPT</p> <p>8971-005</p>	<p>HEX BUSHING, 3/8" MNPT X 1/4" FNPT</p> <p>8971-006</p>	<p>COUPLING, 1/4" FNPT</p> <p>8971-007</p> <p>NOTE: A ZINC PLATED STEEL MERCHANT COUPLING MAY BE SUBSTITUTED AT PURCHASING OPTION.</p>
<p>COUPLING, 1/8" FNPT</p> <p>8971-008</p> <p>NOTE: A ZINC PLATED STEEL MERCHANT COUPLING MAY BE SUBSTITUTED AT PURCHASING OPTION.</p>	<p>REDUCING STREET ELBOW, 1/4" FNPT X 1/8" MNPT</p> <p>8971-009</p>	<p>1/4" BALL VALVE</p> <p>8972</p>

PRESSURE GAUGE KIT

P/N 9439-XXX

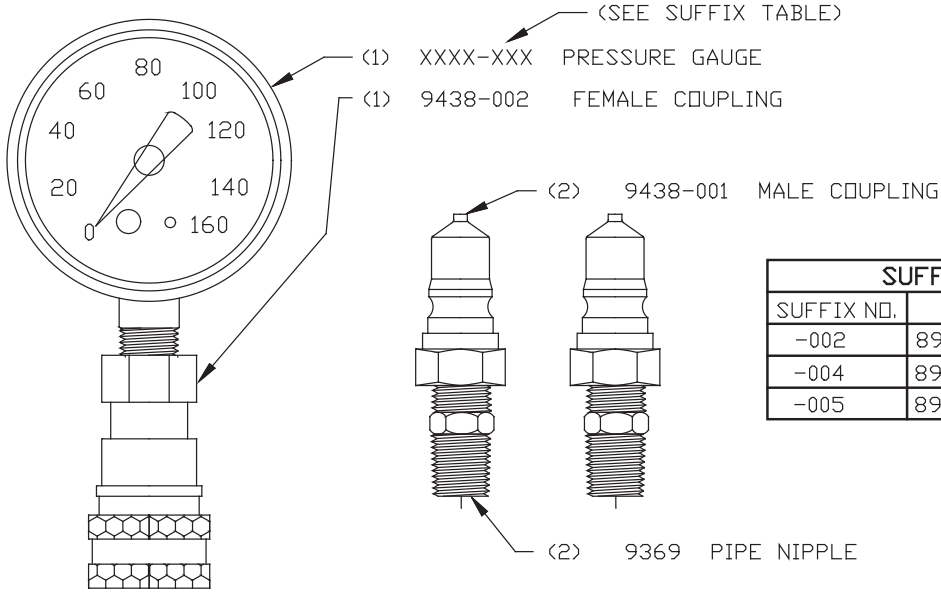

SUFFIX TABLE		
SUFFIX NO.	PRESSURE GAUGE	
-002	8968-002	0-60 PSI
-004	8968-004	0-160 PSI
-005	8968-005	0-200 PSI

NEEDLE VALVE

P/N 9365

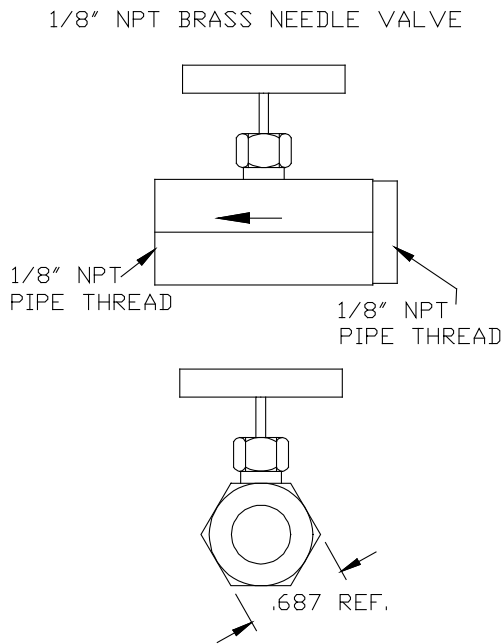

GAUGE & FITTING KIT

P/N 10105-XXX

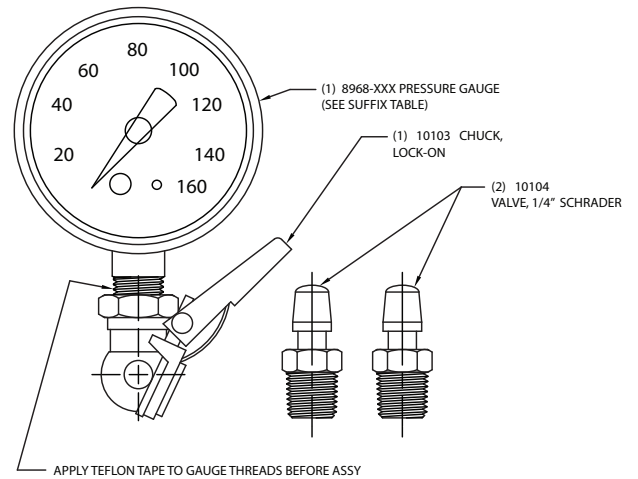

SUFFIX TABLE

KIT NO.	GAUGE NO.	PRESSURE RANGE
10105-001	8968-001	0-30 PSI
10105-002	8968-002	0-60 PSI
10105-003	8968-003	0-100 PSI
10105-004	8968-004	0-160 PSI
10105-005	8968-005	0-200 PSI

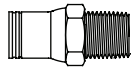
TUBE FITTINGS for 1/4"
P/N 8970-XXX
SUFFIX-001

 STRAIGHT TUBE CONNECTOR
 1/4 TUBE X 1/8 NPT MALE

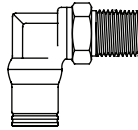
 APPROVED:
 LEGRIS P/N 09855611
 NORGREN 12-425-0418

SUFFIX-002

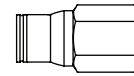
 ELBOW TUBE CONNECTOR
 1/4 TUBE X 1/8 NPT MALE

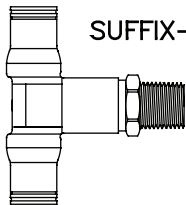
 APPROVED:
 LEGRIS P/N 09895611
 NORGREN 12-447-0418

SUFFIX-003

 STRAIGHT TUBE CONNECTOR
 1/4 TUBE X 1/8 NPT FEMALE

 APPROVED:
 LEGRIS P/N 09845611
 NORGREN 12-426-0418

SUFFIX-004

 TEE TUBE CONNECTOR
 1/4 TUBE X 1/8 NPT MALE

 APPROVED:
 LEGRIS P/N 09885611
 NORGREN 12-467-0418

SUFFIX-005

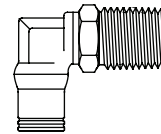
 1/4" (6.4 MM) NYLON TUBING, BLACK IN COLOR
 APPROX. WORKING PRESSURE 250 PSI @ 0°-90° F

SUFFIX-006

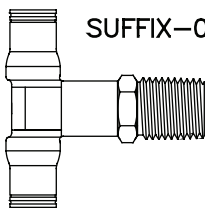
 ELBOW TUBE CONNECTOR
 1/4 TUBE X 1/4 NPT MALE

 APPROVED:
 LEGRIS P/N 09895614
 NORGREN 12-447-0428

SUFFIX-007

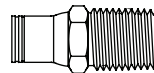
 TEE TUBE CONNECTOR
 1/4 TUBE X 1/4 NPT MALE

 APPROVED:
 LEGRIS P/N 09885614
 NORGREN 12-467-0428

SUFFIX-008

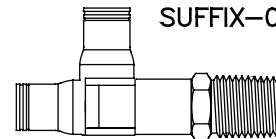
 STRAIGHT TUBE CONNECTOR
 1/4 TUBE X 1/4 NPT MALE

 APPROVED:
 LEGRIS P/N 09855614
 NORGREN 12-425-0428

SUFFIX-009

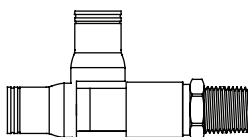
 MALE RUN TEE
 1/4 TUBE X 1/4 NPT MALE

 APPROVED:
 LEGRIS P/N 09835614
 NORGREN 12-468-0428

SUFFIX-010 ①

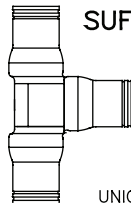
 MALE RUN TEE
 1/4 TUBE X 1/8 NPT MALE

 APPROVED:
 LEGRIS P/N 09835611
 NORGREN 12-468-0418

SUFFIX -011

 UNION TEE
 1/4 TUBE
 APPROVED
 LEGRIS P/N 0954 56 00
 NORGREN 12-060-0400

SUFFIX-013

NOTE: USE WITH 10644 O-RING

 COLLET, NICKEL PLATED
 1/4 TUBE
 (REPAIR/REPLACEMENT)

APPROVED: NORGREN 70900004

NOTE: 1. NORGREN CATALOG NCA-35 SPECIFIES 29.5" VACUUM TO 260 PSIG OPERATING RANGE FOR FITTINGS. THREAD SEALANT IS A NON-PTFE WITH A FOUR YEAR MINIMUM SHELF LIFE (REF.).

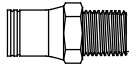
TUBE FITTINGS for 5/32" *
P/N 9526-XXX
SUFFIX-001

 STRAIGHT TUBE CONNECTOR
 5/32 TUBE X 1/8 NPT MALE

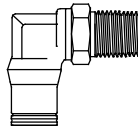
 APPROVED:
 NORGREN 12-425-0218

SUFFIX-002

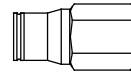
 ELBOW TUBE CONNECTOR
 5/32 TUBE X 1/8 NPT MALE

 APPROVED:
 NORGREN 12-447-0218

SUFFIX-003

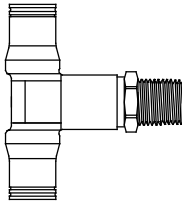
 STRAIGHT TUBE CONNECTOR
 5/32 TUBE X 1/8 NPT FEMALE

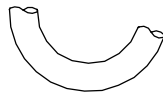
 APPROVED:
 NORGREN 12-426-0218

SUFFIX-004

 TEE TUBE CONNECTOR
 5/32 TUBE X 1/8 NPT MALE
 APPROVED:
 NORGREN 12-467-0218

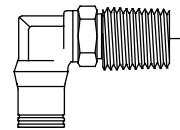
SUFFIX-005

5/32" (4 MM) NYLON TUBING BLACK IN COLOR

SUFFIX-006

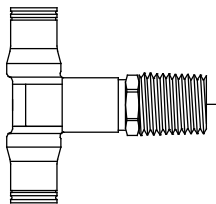
 ELBOW TUBE CONNECTOR
 5/32 TUBE X 1/4 NPT MALE

 APPROVED:
 NORGREN 12-447-0228

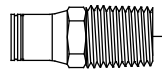
SUFFIX-007

 TEE TUBE CONNECTOR
 5/32 TUBE X 1/4 NPT MALE
 APPROVED:
 NORGREN 12-467-0228

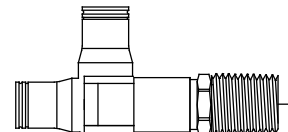
SUFFIX-008

 STRAIGHT TUBE CONNECTOR
 5/32 TUBE X 1/4 NPT MALE

 APPROVED:
 NORGREN 12-425-0228

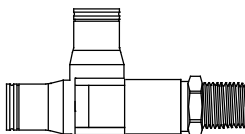
SUFFIX -009

 MALE RUN TEE
 5/32 TUBE X 1/4 NPT MALE

 APPROVED:
 NORGREN 12-468-0228

SUFFIX -010

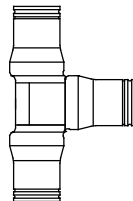
 MALE RUN TEE
 5/32 TUBE X 1/8 NPT MALE

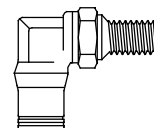
 APPROVED:
 NORGREN 12-468-0218

SUFFIX -011

 UNION TEE
 5/32 TUBE
 APPROVED
 NORGREN 12-060-0200

SUFFIX -012

 ELBOW TUBE CONNECTOR
 5/32 TUBE X 10-32 MALE THRD

 APPROVED:
 NORGREN 12-447-0210

 NOTE: NORGREN CATALOG NCA-35 SPECIFIES THE FOLLOWING.
 29.5' VACUUM TO 260 PSIG OPERATING RANGE FOR FITTINGS.
 THREAD SEALANT IS A NON-PTFE WITH A FOUR YEAR MINIMUM SHELF LIFE (REF.).

* No longer used since 1999

TUBE FITTINGS for 3/8"

P/N 9494-XXX

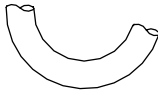
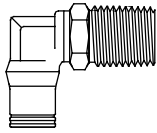
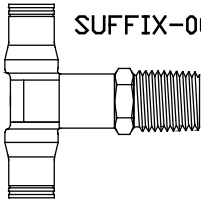
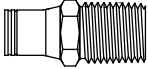
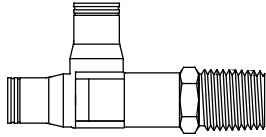
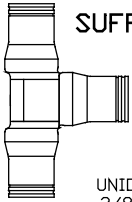
	<p>SUFFIX-005</p>  <p>3/8" (9.5 MM) NYLON TUBING BLACK IN COLOR</p>	<p>SUFFFIX-006</p>  <p>ELBOW TUBE CONNECTOR 3/8 TUBE X 1/4 NPT MALE</p> <p>APPROVED: NORGREN 12-447-0628</p>
 <p>SUFFIX-007</p> <p>TEE TUBE CONNECTOR 3/8 TUBE X 1/4 NPT MALE</p> <p>APPROVED: NORGREN 12-467-0628</p>	<p>SUFFIX-008</p>  <p>STRAIGHT TUBE CONNECTOR 3/8 TUBE X 1/4 NPT MALE</p> <p>APPROVED: NORGREN 12-425-0628</p>	<p>SUFFIX -009</p>  <p>MALE RUN TEE 3/8 TUBE X 1/4 NPT MALE</p> <p>APPROVED: NORGREN 12-468-0628</p>
 <p>SUFFIX-011</p> <p>UNION TEE 3/8 TUBE</p> <p>APPROVED NORGREN 12-060-0600</p>		

NOTE: NORGREN CATALOG NCA-35 SPECIFIES THE FOLLOWING.
29.5" VACUUM TO 260 PSIG OPERATING RANGE FOR FITTINGS.
THREAD SEALANT IS A NON-PTFE WITH A FOUR YEAR MINIMUM SHELF LIFE (REF.).

FLANGE ADAPTER KIT

Part #	Adapter Kit	Included Stud Kit
11433	4" Valve x	—
11433-001	6" ANSI Flange	6" Stud Kit (#8976)
12225	6" Valve x	—
12225-001	8" ANSI Flange	8" Stud Kit (#9524)

Valves with flange adapters require extension kits for the manual selector and the solenoid/pilot mounting bracket to prevent interference with the studs.

Extension Hardware Included with Adapter Kits

Part #	Description	Qty
11468	Female Adapter	1
9369-020	Pipe Nipple, 1/4"	1
9325	Extension Bracket	1
6818	Screw, 1/4"	2
8904	Washer, 1/4"	2
6060	Nut, 1/4"	2
10217	Screw 5/16"	2
7029	Washer, 5/16"	2

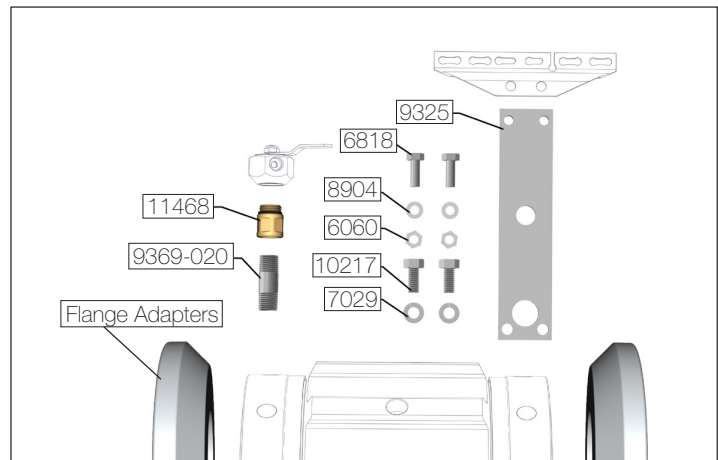

Extension Kit Installation Instructions

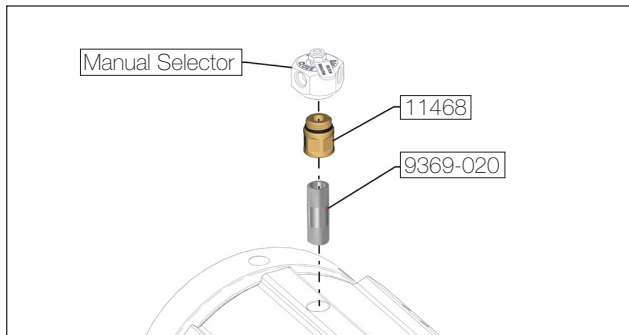

Install Manual Selector Extension

- Un-screw the manual selector from the valve.
- Replace the 1/4" male adapter on the bottom of the selector with the Female Adapter (11468).
- Thread the 1/4" Nipple (9369-020) into the female adapter (11468).
- Thread the completed assembly into the valve.

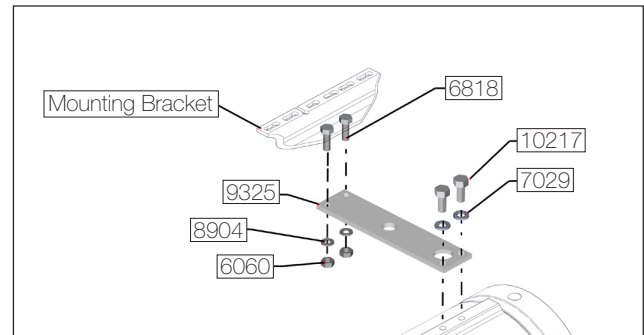

Install Extension Mounting Bracket

- Remove the existing mounting bracket from the valve.
- Mount the extension bracket (9325) to the valve.
 Note: The extension bracket can be bent to fit the desired angle of installation. This can be done by hand with it mounted on the valve, or by placing the extension bracket in a vise before mounting.
- Attach the mounting bracket to the extension bracket.