

CONTENTS

Overview

Assemblies and Components2

4 mm Tubing (Max 20 gph / 76 lph)

Universal Mounting System3

Upright4

Hanging6

Obsolete (FT-02, FT-04, 1/2" PVC-4)7

Accessories8

5 mm Tubing (Max 40 gph / 151 lph)

Universal Mounting System9

Upright11

Hanging14

Obsolete (FT1).....15

Accessories16

10 mm Tubing (Max 2.0 gpm / 454 lph)

Upright17

Inverted18

Accessories19

Adapters

Retrofit Sprinklers to Existing Stakes 20

ASSEMBLIES AND COMPONENTS

Stake and Tube Assembly

Includes all components, factory-assembled. Available for PVC and plastic stake models only.

Adapter & LTO Assembly

Includes **Adapter** assembled to **Tube & LTO**. Stakes must be ordered separately.

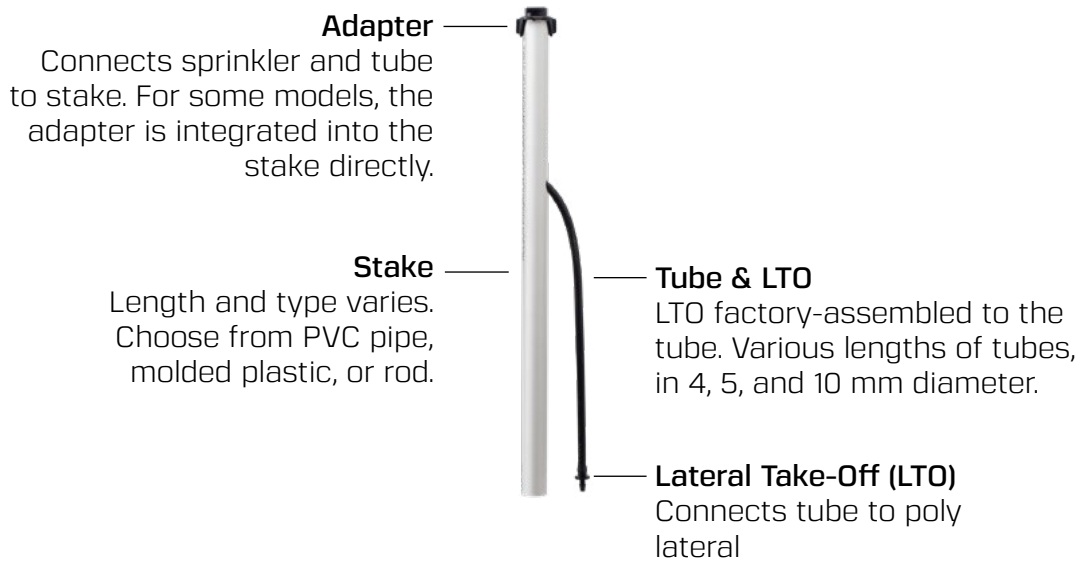

MODEL OVERVIEW

Sprinkler	Mount	Stake	Assembly		
			4 mm	5 mm	10 mm
5 Series	Upright	Molded Plastic	FT-01	FT3	-
		Rod	FT-03	-	-
		PVC	-	1/2" or 3/4" PVC-5	-
7 Series	Upright	Molded Plastic	16" QC4	16" QC5	-
		PVC	1/2" PVC-4 QC	1/2" PVC-5 QC	-
	Universal	Rod or PVC	UQC-4	UQC-5	-
10 Series	Upright	Molded Plastic	-	FT3	-
		Rod	-	-	FT4, FT5
		Rod or PVC	-	UA5	-
	PVC	-	1/2" or 3/4" PVC-5	3/4" PVC-10	
Inverted	PVC	-	-	3/4" PVC-10	
2000 Series	Upright	Rod	-	-	FT4, FT5
		PVC	-	-	3/4" PVC-10



4 MM, QC UNIVERSAL MOUNTING SYSTEM

Field-assembly of components. Start with the Adapter & LTO assembly with the desired length of tube, then order the other components separately.
 Max flow 20 gph (76 lph)

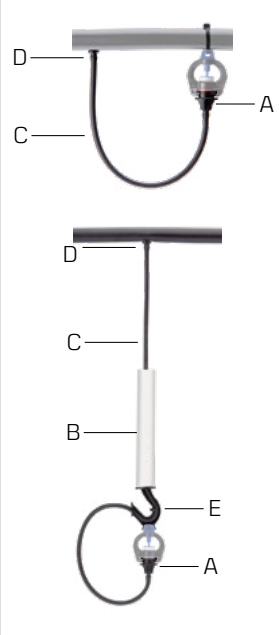
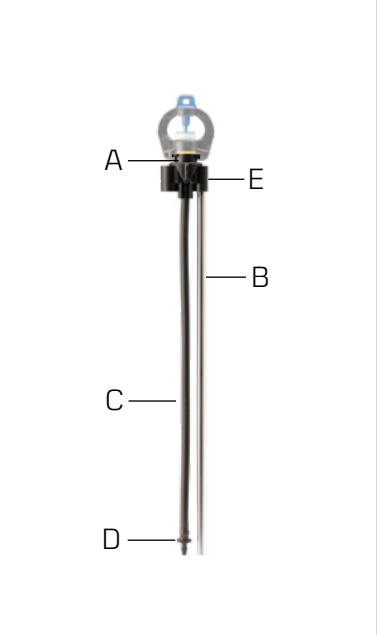
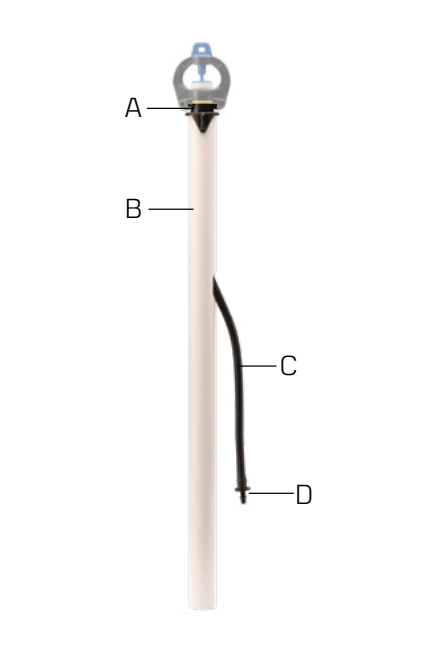
MODEL		UQC-4		
Application	Hanging S7 from poly laterals	Rod Stake for 7 Series	PVC Stake for 7 Series	
Connection to Sprinkler	7 Series QC			
ASSEMBLIES				
Stake & Tube	Not Available			
Adapter & LTO	12" (13092-012) / 18" (13092-018) / 24" (13092-024) / 30" (13092-030) / 48" (13092-048)			
COMPONENTS				
				
(A) Adapter	UQC-4, QC x 1/2" PVC x 4 mm Barb (12990-002)			
(B) Stake	Supplied by others (1/2" PVC pipe serves as a weight)	6.3mm x 24" (61 cm) Steel (9726-024), or Fiberglass (10040-024)	1/2" PVC 16" (40 cm) (11259-216) 22" (56 cm) (11259-222)	
(C) Tube & LTO	12" (9960-912) / 18" (9960-918) / 24" (9960-924) / 30" (9960-930) / 48" (9960-948)			
(D) LTO	4 mm Barb x Barb (10080)			
(E) Other	Hanging bracket (13395)	6.3 & 8 mm Universal Rod Stake Adapter (13608)	NA	



4 MM, UPRIGHT

For 5 Series Sprinklers
Max flow 20 gph (76 lph)

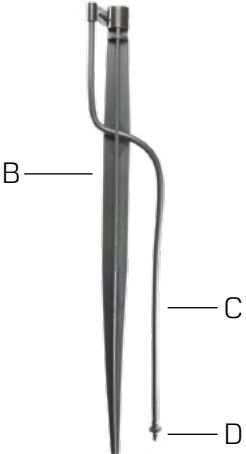
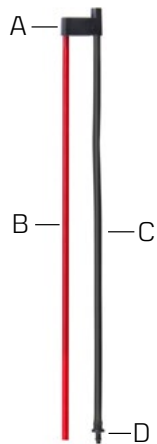
MODEL	FT-01	FT-03
Application	Economical stake and tube assembly for the R5.	Mount R5 to Rod Stake
Connection to Sprinkler	5 Series nozzle threads into tube	
ASSEMBLIES		
Stake & Tube	12" (30 cm) Stake w/ 24" tube (10745-024) or 36" tube (10745-036)	175" (45 cm) Stake w/ 36" tube (10744-036)
Adapter & LTO	Not Available	
COMPONENTS		
		
(A) Adapter	NA	Rod Stake x 4 mm (10136)
(B) Stake	12" (30 cm) (10847) / 175" (45 cm) (10848)	6.3mm x 24" (61 cm), Steel (9726-024) or Fiberglass (10040-024)
(C) Tube & LTO	24" (9960-924) / 30" (9960-930) / 48" (9960-948)	
(D) LTO	4 mm Barb x Barb (10080)	



4 MM, UPRIGHT

For 7 Series Sprinklers
Max flow 20 gph (76 lph)

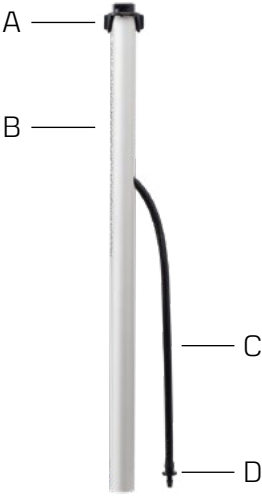
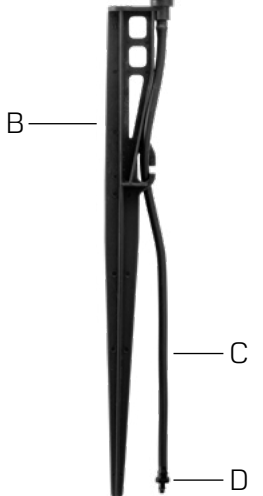
MODEL	1/2" PVC-4 QC			16" QC4	
Application	Durable 1/2" PVC stake and tube assembly			Economical stake and tube assembly.	
Connection to Sprinkler	7 Series QC				
ASSEMBLIES					
Stake & Tube	16" (40 cm) Stake w/ 30" Tube (13090-21630)	16" (40 cm) Stake w/ 48" Tube (13090-21648)	22" (56 cm) Stake w/ 30" Tube (13090-22230)	16" (40 cm) Stake w/ 30" Tube (12983-21630)	16" (40 cm) Stake w/ 48" Tube (12983-21648)
Adapter & LTO	30" (76 cm) (13092-030) / 48" (122 cm) (13092-048)			NA	
COMPONENTS					
					
(A) Adapter	UQC-4, QC x 1/2" PVC x 4 mm Barb (12990-002)			NA	
(B) Stake	1/2" PVC 16" (40 cm) (11259-216) 22" (56 cm) (11259-222)			16" (40 cm) x QC (12981-002)	
(C) Tube & LTO	30" (9960-930) / 48" (9960-948)				
(D) LTO	4 mm Barb x Barb (10080)				



4 MM, HANGING

Drop assemblies for hanging 7 Series
Max flow 20 gph (76 lph)

MODEL	UQC-4		Trellis Clip
Application	Hanging S7 from poly laterals		Hanging S7 from trellis wire
Connection to Sprinkler	7 Series QC		
ASSEMBLIES			
Stake & Tube	Not Available		
Adapter & LTO	12" (13092-012) / 18" (13092-018) / 24" (13092-024) / 30" (13092-030) / 48" (13092-048)		NA
COMPONENTS			
(A) Adapter	UQC-4, QC x 1/2" PVC x 4 mm Barb (12990-002)		
(B) Stake	NA	Supplied by others (1/2" PVC pipe serves as a weight)	NA
(C) Tube & LTO	12" (9960-912) / 18" (9960-918) / 24" (9960-924) / 30" (9960-930) / 48" (9960-948)		NA
(D) LTO	4 mm Barb x Barb (10080)		NA
(E) Other	NA	Hanging bracket (13395)	Trellis Clip (13862)



4 MM, OBSOLETE

These assemblies have been discontinued, but parts are available.

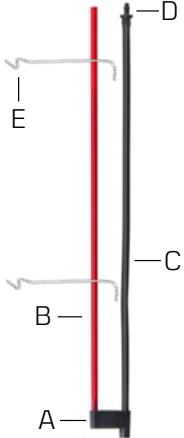
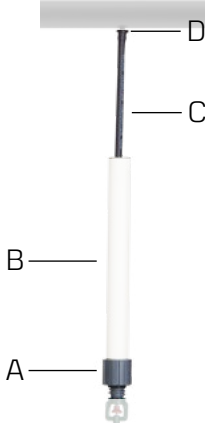
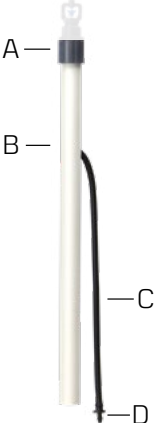
MODEL	FT-02	FT-04	1/2" PVC-4
Application	Mount R5 (Wine Plate) to trellis wire	Hanging the S5 Spinner from poly tube	Mount R5 to PVC Stake
Connection to Sprinkler	R5 nozzle threads into tube	1/2" Male Acme / S5 nozzle threads into tube	1/2" Male Acme / R5 nozzle threads into tube
ASSEMBLIES			
Stake & Tube Adapter & LTO	DISCONTINUED		
COMPONENTS			
			
(A) Adapter	Rod Stake x 4 mm (10136)	1/2" Male Acme x 1/2" PVC x 4 mm Compression (11258)	
(B) Stake	6.3 mm x 24" (61 cm) Steel (9726-024), or Fiberglass (10040-024)	Supplied by others (1/2" PVC pipe serves as a weight)	1/2" PVC 16" (40 cm) (11259-216) 22" (56 cm) (11259-222)
(C) Tube & LTO	4 mm x 12" (9960-912) / 18" (9960-918) / 24" (9960-924) / 30" (9960-930) / 48" (9960-948)		
(D) LTO	4 mm Barb x Barb (10080)		
(E) Other	Hanger rod clip (9987)	NA	

4 MM ACCESSORIES

TOOLS	
Hand Punch	Green 4 mm Barb (10997)
Plastic Stake Installation	16" QC4/QC5, FT3, FT-01 (13429)
Rod Stake Installation	6.3 mm Rod (10287) Universal Rod (14000)
Universal Tubing Guide	Assemble UQC/UA4 Adapter & LTO to PVC Stake (13784)



10997
Hand Punch



13429
Plastic Stake
Install Tool



10287
6.3 mm Rod Stake
Install Tool



14000
Universal Rod
Stake Install Tool



13784
Universal Tubing
Guide

TUBING, FITTINGS, ETC.	
Tubing Coil	4 mm x 328' (100 m) (10081) 4 mm x 1000' (305 m) (10082-002)
Goof Plug	13435 (order in multiples of 6)
Tubing Coupler	4 mm x 4 mm Barb (10080) 4 mm x 5 mm Barb (13142)
Hanging Bracket	13395
Universal Rod Stake Adapter	6.3 & 8 mm Rod to UQC/UA Adapter (13608)



13435
Goof Plug



(see table)
Tubing Coupler



13395
Hanging Bracket



13608
Universal Rod
Stake Adapter



5 MM, QC UNIVERSAL MOUNTING SYSTEM

Field-assembly of components. Start with the Adapter & LTO assembly with the desired length of tube, then order the other components separately.
 Max flow 40 gph (151 lph)

MODEL		UQC-5	
Application	Hanging S7 from poly laterals	Rod Stake for 7 Series	PVC Stake for 7 Series
Connection to Sprinkler	7 Series QC		
ASSEMBLIES			
Stake & Tube	Not Available		
Adapter & LTO	24" (13091-024) / 30" (13091-030) / 48" (13091-048) / 72" (13091-072)		
COMPONENTS			
(A) Adapter	UQC-5, QC x 1/2" PVC x 5 mm Barb (12990-001)		
(B) Stake	Supplied by others (1/2" PVC pipe serves as a weight)	6.3 mm x 24", Steel (9726-024) or Fiberglass (10040-024)	1/2" PVC 16" (40 cm) (11259-216)
		8 mm x 24", Steel (9725-024) or Fiberglass (10160)	22" (56 cm) (11259-222)
(C) Tube & LTO	24" (11283-024) / 30" (11283-030) / 48" (11283-048) / 72" (11283-072)		
(D) LTO	5 mm Barb x Barb (12023)		
(E) Other	Hanging bracket (13395)	6.3 & 8 mm Universal Rod Stake Adapter (13608)	NA

5 MM, ACME UNIVERSAL MOUNTING SYSTEM

Field-assembly of components. Start with the Adapter & LTO assembly with the desired length of tube, then order the other components separately.

Max flow 40 gph (151 lph)

MODEL	UA-5	
Application	Rod Stake for R10	PVC Stake for R10
Connection to Sprinkler	1/2" Male Acme	
ASSEMBLIES		
Stake & Tube	Not Available	
Adapter & LTO	30" (13693-030) / 48" (13693-048)	
COMPONENTS		
(A) Adapter	UA-5, 1/2" Male Acme x 1/2" PVC x 5 mm Comp. (13099)	
(B) Stake	6.3 mm x 24", Steel (9726-024) or Fiberglass (10040-024)	1/2" PVC 16" (40 cm) (11259-216) 22" (56 cm) (11259-222)
	8 mm x 24", Steel (9725-024) or Fiberglass (10160)	
(C) Tube & LTO	30" (11283-030) / 48" (11283-048)	
(D) LTO	5 mm Barb x Barb (12023)	
(E) Other	6.3 & 8 mm Universal Rod Stake Adapter (13608)	NA

5 MM, UPRIGHT

For 5 and 10 Series Sprinklers
 Max flow 40 gph (151 lph)

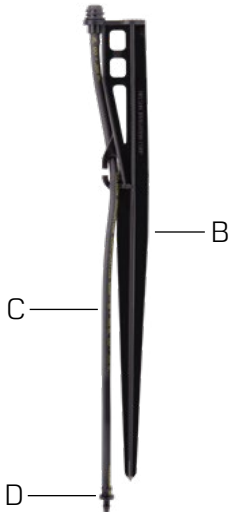
MODEL		FT3	
Application	Economical stake and tube assembly.		
Connection to Sprinkler	1/2" Male Acme		
ASSEMBLIES			
Stake & Tube	16" (40 cm) Stake w/ 30" Tube (13154-030)	16" (40 cm) Stake w/ 48" Tube (13154-048)	
Adapter & LTO	NA		
COMPONENTS			
			
(A) Adapter	NA		
(B) Stake	16" (40 cm) x 1/2" Male Acme (12981-003)		
(C) Tube & LTO	30" (11283-030) / 48" (11283-048) / 72" (11283-072)		
(D) LTO	5 mm Barb x Barb (12023)		

5 MM, UPRIGHT

For 5 and 10 Series Sprinklers
 Max flow 40 gph (151 lph)

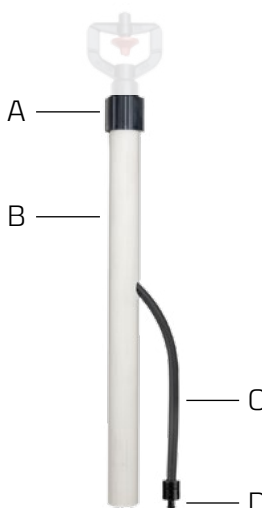
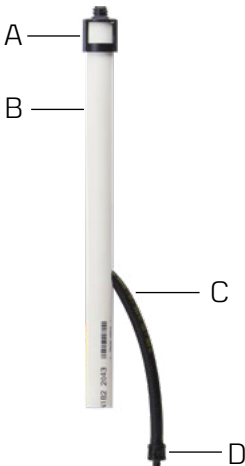
MODEL	1/2" PVC-5			3/4" PVC-5
Application	Durable 1/2" PVC stake for 5 and 10 Series			Durable 3/4" PVC stake for 5 and 10 Series
Connection to Sprinkler	1/2" Male Acme			
ASSEMBLIES				
Stake & Tube	16" (40 cm) Stake w/30" Tube (11284-21630)	22" (56 cm) Stake w/30" Tube (11284-22230)	22" (56 cm) Stake w/48" Tube (11284-22248)	22" (56 cm) Stake w/30" Tube (11455-12230)
Adapter & LTO	Not Available			
COMPONENTS				
				
(A) Adapter	1/2" Male Acme x 1/2" PVC x 5 mm Comp. (11271)			1/2" Male Acme x 3/4" PVC x 5 mm Comp. (11429)
(B) Stake	1/2" PVC 16" (40 cm) (11259-216) 22" (56 cm) (11259-222)			3/4" PVC 22" (56 cm) (11453-022)
(C) Tube & LTO	30" (11283-030) / 48" (11283-048) / 72" (11283-072)			
(D) LTO	5 mm Barb x Barb (12023)			



5 MM, UPRIGHT

For 7 Series Sprinklers
Max flow 40 gph (151 lph)

MODEL	1/2" PVC-5 QC			16" QC5	
Application	Durable 1/2" PVC stake and tube assembly, factory assembled.			Economical stake and tube assembly.	
Connection to Sprinkler	7 Series QC				
ASSEMBLIES					
Stake & Tube	16" (40 cm) Stake w/ 30" Tube (13089-21630)	22" (56 cm) Stake w/ 30" Tube (13089-22230)	22" (56 cm) Stake w/ 48" Tube (13089-22248)	16" (40 cm) Stake w/ 30" Tube (12982-21630)	16" (40 cm) Stake w/ 48" Tube (12982-21648)
Adapter & LTO	30" (13091-030) / 48" (13091-048)			NA	
COMPONENTS					
(A) Adapter	UQC-5, QC x 1/2" PVC x 5 mm Barb (12990-001)			NA	
(B) Stake	1/2" PVC 16" (40 cm) (11259-216) 22" (56 cm) (11259-222)			16" (40 cm) x QC (12981-002)	
(C) Tube & LTO	30" (11283-030) / 48" (11283-048) / 72" (11283-072)				
(D) LTO	5 mm Barb x Barb (12023)				



5 MM, HANGING

Drop assemblies for 7 Series hanging sprinklers
Max flow 40 gph (151 lph)

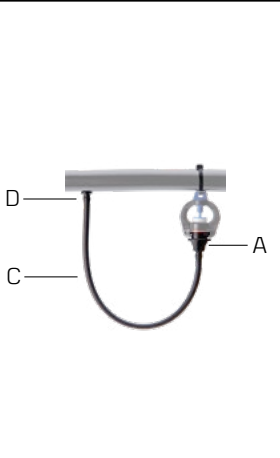
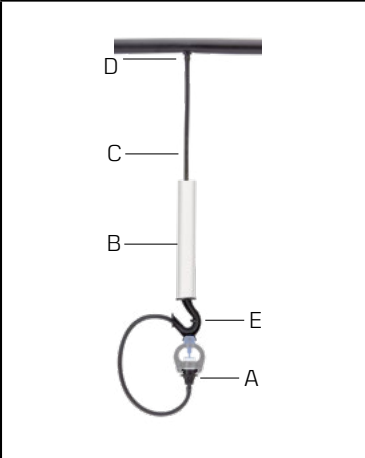
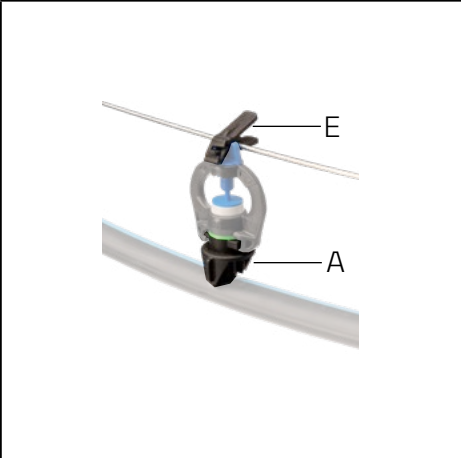
MODEL	UQC-5		Trellis Clip
Application	For hanging S7 from poly laterals		Hanging 7 Series from trellis wire
Connection to Sprinkler	7 Series QC		
ASSEMBLIES			
Stake & Tube	Not Available		
Adapter & LTO	24" (13091-024) / 30" (13091-030) / 48" (13091-048) / 72" (13091-072)		NA
COMPONENTS			
			
(A) Adapter	UQC-5, QC x 1/2" PVC x 5 mm Barb (12990-001)		
(B) Stake	NA	Supplied by others (1/2" PVC pipe serves as a weight)	NA
(C) Tube & LTO	24" (11283-024) / 30" (11283-030) / 48" (11283-048) / 72" (11283-072)		NA
(D) LTO	5 mm Barb x Barb (12023)		NA
(E) Other	NA	Hanging bracket (13395)	Trellis Clip (13862)

5 MM, OBSOLETE

These assemblies have been discontinued, but parts are available.

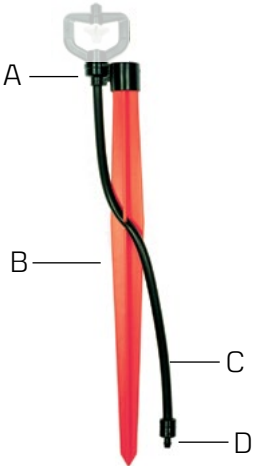
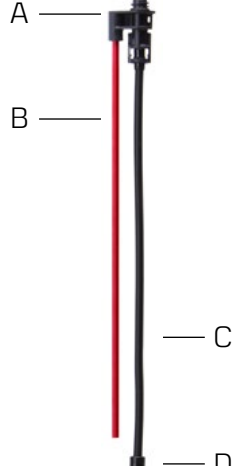
MODEL	FT1	FT2
Application	Mounting 3/8" MNPT R10 to legacy plastic stake	Rod Stake for 5 or 10 Series
Connection to Sprinkler	3/8" FNPT	1/2" Male Acme
ASSEMBLIES		
Stake & Tube	DISCONTINUED	DISCONTINUED
Adapter & LTO		
COMPONENTS		
		
(A) Adapter	3/8" FNPT x Stake Collar x 5 mm Compression (9262)	1/2" Male Acme x Rod Stake x 5 mm Compression (9677)
(B) Stake	DISCONTINUED	Steel Rod, 6.3 mm x 24" (9726-024) / Fiberglass, 6.3 mm x 18" (10040-018) or 24" (10040-024)
(C) Tube & LTO	5 mm x 30" (11283-030) or 48" (11283-048)	30" (11283-030) / 48" (11283-048) / 72" (11283-072)
(D) LTO	5 mm Barb x Barb (12023), or Compression x Barb (9305)	5 mm Barb x Barb (12023)

5 MM ACCESSORIES

TOOLS	
Hand Punch	Red 5 mm Barb (9349)
Drill Punch	5 mm (9835-003)
Plastic Stake Installation	16" QC4/QC5, FT3, FT-01 (13429)
Rod Stake Installation	6.3 mm Rod (10287) Universal Rod (14000)
Universal Tubing Guide	Assemble UQC/UA4 Adapter & LTO to PVC Stake (13784)



9349
Hand Punch



9835-003
5 mm Drill Punch



13429
Plastic Stake Install Tool



10287
6.3 mm Rod Stake Install



14000
Universal Rod Stake Install



13784
Universal Tubing Guide

TUBING, FITTINGS, ETC.	
Tubing Coil	5 mm x 328' (100 m) (9284-002) 5 mm x 1000' (305 m) (9284)
Goof Plug	13435 (order in multiples of 6)
Tubing Coupler	5 mm x 5 mm Barb (12023) 4 mm x 5 mm Barb (13142)
Hanging Bracket	13395
Universal Rod Stake Adapter	6.3 & 8 mm Rod to UQC/UA Adapter (13608)
Stake Collar Adapter	Convert Assembly FT2/FT4/FT5 to 3/4" PVC stake (9195)



13435
Goof Plug



(see table)
Tubing Coupler



13608
Universal Rod Stake Adapter





13395
Hanging Bracket



9195
Stake Collar Adapter

10 MM, UPRIGHT

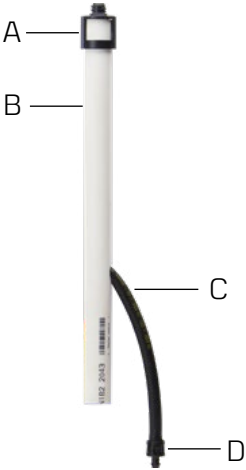
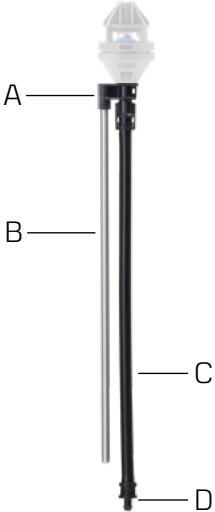
For 10 and 2000 Series Sprinklers
 Max flow 2.0 gpm (454 lph)

MODEL	3/4" PVC-10	FT4	FT5
Application	Durable 3/4" PVC stake and tube assembly	Rod Stake for 10 and 2000 Series	Quick-connect assembly for portable laterals
Connection to Sprinkler	1/2" Male Acme		
ASSEMBLIES			
Stake & Tube	22" (56 cm) Stake w/36" Tube (11452-12236)	NA	NA
Adapter & LTO	NA	36" (9752-036)	48" (9737-048)
COMPONENTS			
			
(A) Adapter	1/2" Male Acme x 3/4" PVC x 10 mm Barb/Comp. (11429)	1/2" Male Acme x 8 mm Stake x 10mm Barb/Comp. (9677)	
(B) Stake	22" x 3/4" PVC (11453-022)	8 mm x 24", Steel (9725-024) or Fiberglass (10160)	
(C) Tube & LTO	NA		
(D) LTO	10 mm Compression x 7 mm Barb (9774)	10 mm Comp. x Male QC (9740) & Female QC x 10 mm Barb (9739)	



10 MM, INVERTED

Drop assemblies for 10 Series inverted sprinklers
 Max flow 2.0 gpm (454 lph)

MODEL	3/4" PVC-10
Application	Inverted S10, MS10
Connection to Sprinkler	1/2" Male Acme
ASSEMBLIES	
Stake & Tube	NA
Adapter & LTO	24" (13861-024)
COMPONENTS	
(A) Adapter	1/2" Male Acme x 3/4" PVC x 10 mm Barb (11429)
(B) Stake	Supplied by others (3/4" PVC pipe serves as a weight)
(C) Tube & LTO	NA
(D) LTO	10 mm Compression x 7 mm Barb (9774)

10 MM ACCESSORIES

TOOLS	
Hand Punch	Blue 7 mm Barb (9810) White 10 mm Barb (9776)
Drill Punch	7 mm Barb (9835-002) 10 mm Barb (9835-001)
Drill Installation, QC Barb	for FT5 (9845)
Rod Stake Installation	8 mm Rod (10288)



(see table)
Hand Punch



(see table)
Drill Punch



9845
QC Barb Drill Install Tool



10288
Rod Stake Install Tool

TUBING, FITTINGS, ETC.	
Tubing Coil	500' (152 m) (9099)
Goof Plug	7 mm (10301)
FT5 Parts	Female QC x 10 mm Barb (9739)
	10 mm Goof Plug (9831)
	QC Rubber Plug (9826)
Tubing Coupler	10 mm (9813)
Stake Collar Adapter	Convert Assembly FT2/FT4/FT5 to 3/4" PVC stake (9195)



10301
7 mm
Goof Plug



9831
10 mm
Goof Plug



9739
Female QC x
10 mm Barb



9826
QC Rubber Plug
(goes in 9739)



9813
10 mm Tubing
Coupler



9195
Stake Collar
Adapter

ADAPTERS

Retrofit sprinklers to existing stakes.

1/2" ACME ADAPTERS	
1/2" Female Acme Inlet	x R5 (10616) x Drip Barb Tee (12431) x QC, w/Screen (12972) x QC, NO Screen (12929) Acme Cap (10615)
	3/8" (9465) 1/2" (9316-002) 3/4" (9466)
MNPT x 1/2" Male Acme	1/2" (10060-001) 3/4" (10060-002) 25 mm (10060-003)



10616
1/2" Female Acme x R5



12431
1/2" Female Acme x Drip Barb Tee



(see table)
1/2" Female Acme x QC



10615
Acme Cap



(see table)
MNPT x 1/2" Male Acme



(see table)
PVC Socket x 1/2" Male Acme

7 SERIES QC ADAPTERS	
MNPT x QC	1/2" (13064-001) 3/8" (13064-002)
	w/Screen (12972) NO Screen (12929)
SuperNet Stake	0.256" OD Tube x QC (12882-001)



(see table)
MNPT x QC



(see table)
1/2" Female Acme x QC



12882-001
SuperNet Stake
0.256" OD Tube x QC